

European P.C.B. type terminal blocks / EK series

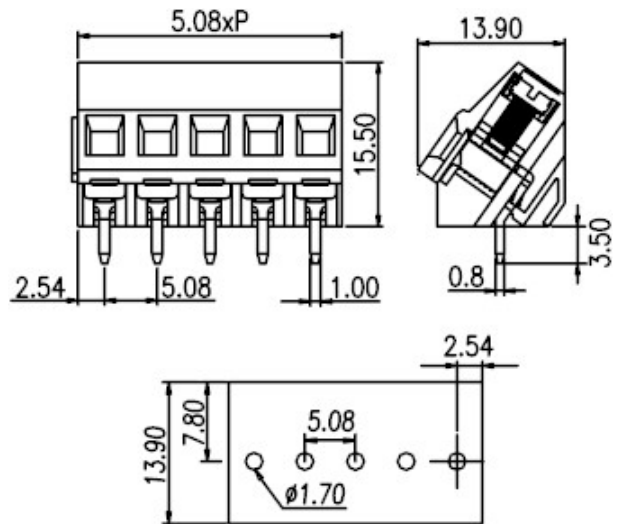

EK508A

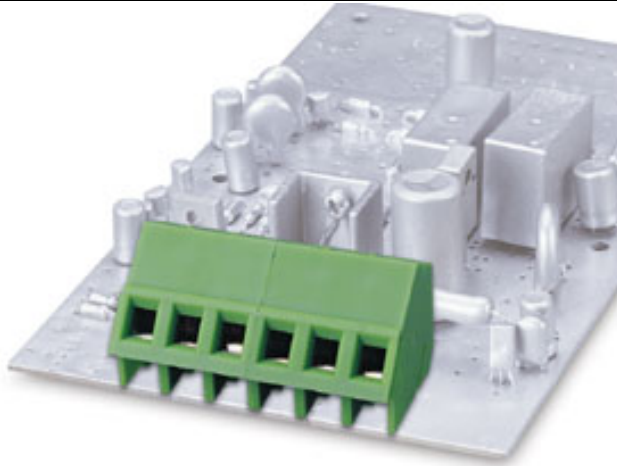

Pitch: 5.08mm

Approval		
Technical Data	UL	IEC
Rated voltage	300V	250V
Rated current	20A	10A
Wire range		2.5mm ²
Solid wire (AWG)	24~12	
Stranded wire (AWG/mm ²)	24~12	
Rated surge voltage (UL/IEC/Max.)	1.6 / 2 / 3 KV	
Torque (Lb-in)	4.4	
Screw	M2.5	
Wire strip length	6~7mm	
Pole	Cat. No.	
02	EK508A-02P	
03	EK508A-03P	

TEL: +886-2-2908-0614

FAX: +886-2-2908-8549

E-mail: infor@dinkle.com.tw